

Hugo TT 2

Manual

V.1.0



Chord Electronics Ltd.

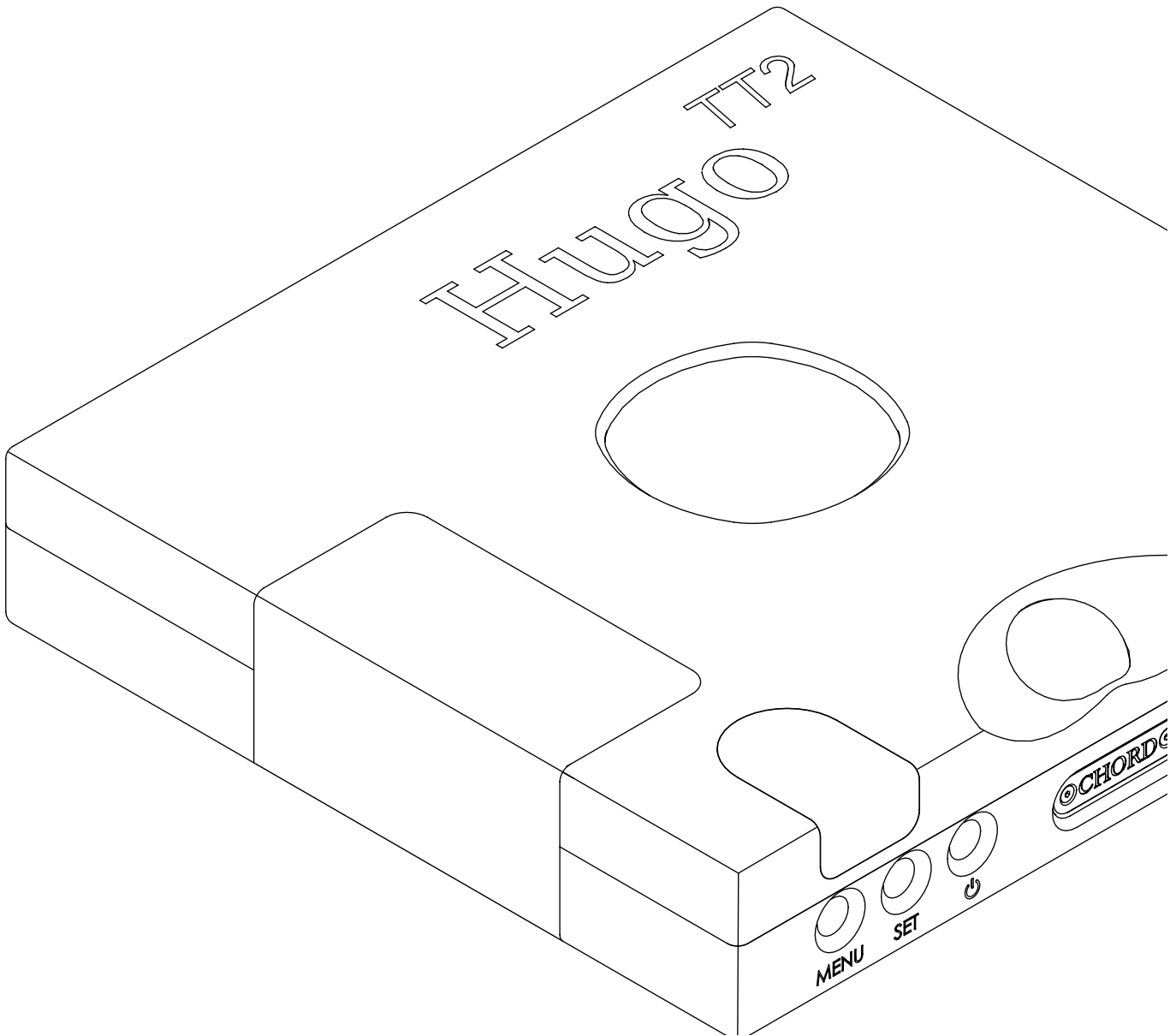

Contents

0.0

1.0 Safety instructions	07	2.0 Warranty	13
1.1 Introduction	08	2.1 Warranty period & registering your purchase	14
1.2 Protection against liquids & heat	09	2.2 Making a claim & warranty exclusions	15
1.3 Dismantling & Radio Frequency interference	10		
1.4 Connecting your equipment	11		
3.0 Getting to know Hugo TT 2	17	4.0 Setting up Hugo TT 2	25
3.1 Getting to know Hugo TT 2 & Drivers	18	4.1 Placement	26
3.2 The front panel	20	4.2 Connecting Hugo TT 2 to equipment & Hugo TT 2 power-on sequence	27
3.3 The top panel	21		
3.4 The rear panel	22		
3.5 The remote control	23		
5.0 How to navigate the menus	29	6.0 Gain range and Input	33
5.1 The screen & navigating the menu	30	6.1 Gain range	34
5.2 The volume ball & its colours and the Sample rate indicator	31	6.2 Input	35
7.0 Playback modes	37	8.0 Special Features	43
7.1 Playback modes	38	8.1 Crossfeed (XFD) & Filters (FIL)	44
7.2 Headphone mode	39	8.2 Display dimming, settings memory, supercapacitors & galvanic isolation	45
7.3 Amplification mode	40		
7.4 DAC mode	41		

0.0

Contents

Safety instructions

1.0

- 1.1 Introduction
- 1.2 Protection against liquids & heat
- 1.3 Dismantling & Radio Frequency interference
- 1.4 Connecting your equipment

1.0 *Safety instructions*

Introduction

1.1



The Hugo TT 2 is an incredibly powerful and versatile digital-to-analogue converter and pre/headphone amplifier.

Before operation, we strongly advise you read this User Manual thoroughly.

We also recommend that you store this User Manual, along with your original receipt of purchase, in a safe place should you require assistance in the future.



 *Made in* **BRITAIN**

Protection against liquids & heat

1.2



The Hugo TT 2 is not protected against liquids of any kind. Never place containers of liquid on Hugo TT 2. Never allow Hugo TT 2 to come into contact with moisture or liquids; doing so could result in electrocution or damage to the Hugo TT 2's internal circuitry.

Be aware that liquids, including water that has dried, can leave minerals that can affect the PCB and other components, which could eventually lead to oxidation and short-circuiting.

If the Hugo TT 2 comes into contact with moisture or liquids, immediately disconnect from the mains power supply, and connected equipment, and contact Chord Electronics for further advice.



The Hugo TT 2 has internal thermal protection which will shut down the unit in the event of excessive temperatures being reached. Never operate the Hugo TT 2 near sources of heat or naked flames as this will decrease the lifespan of the internal components.

It is advised that you do not operate the Hugo TT 2 in an area of direct sunlight or on top of significant heat-producing devices.

Please be aware that it is entirely normal for the Hugo TT 2 to become warm during use, particularly within a stacked configuration.

If you are concerned about the temperatures, please switch the device off using the front panel or consider a different placement.

Dismantling & radio frequency interference

1.3



There are no user-serviceable components within the **Hugo TT 2** or its power supply. Dangerous voltages/currents exist within the **Hugo TT 2** and its power supply, posing a severe risk of electrocution and/or fire.



Never attempt to open, dismantle or apply internal third-party devices to it or insert anything other than the listed interconnects or headphone adapters within this user manual.

If the **Hugo TT 2** develops a fault or the casework becomes damaged, immediately disconnect from the mains power supply and connected equipment, and contact **Chord Electronics** for further advice.

With a thick, solid aluminium chassis, the Hugo TT 2's casework largely protects the sensitive internal circuitry from radio frequency interference. However, for optimal performance, it is recommended that the following points are observed:



1. Consider placing the Hugo away from wireless routers.



2. Separate the Hugo TT 2 from amplifiers using toroidal transformers.



3. Operate mobile phones at a distance to avoid interference.



Although the Hugo TT 2 is largely shielded, it can generate radio frequency interference that may have an effect on radio and television reception. If this occurs, please reconsider your placement.

Connecting your equipment 1.4

Before connecting the Hugo TT 2 to any equipment, consult the manufacturer's user guide to confirm compatibility.

When connecting the Hugo TT 2 to any equipment, make sure that all devices are off, including the Hugo TT 2.

Once connected, switch all equipment on starting with the source and ending with the amplification.

Initially, operate the Hugo TT 2 on its lowest gain setting and lowest volume setting, gently increasing to a comfortable listening level.

Never operate the Hugo TT 2 at excessive sound levels; permanent hearing damage and loss can occur.

Unlike the original Hugo TT, the Hugo TT 2 does not have internal batteries and, therefore, must be permanently connected to a source of power.

The included 15V 4000mA power supply simply plugs into the Hugo TT 2.

If the power supply is prematurely disconnected Hugo TT 2 may still remain active for up to 15 seconds, however, this may cause damage to connected equipment.

 Never disconnect the power cable during operation. Only disconnect when Hugo TT 2 is off. If the power cable is disconnected during operation there is a risk of damage to connected equipment.



Warranty

2.0

- 2.1 Warranty period & registering your purchase
- 2.2 Making a claim & warranty exclusions

2.0 *Warranty*

Warranty period & registering your purchase

2.1

At point of sale, Chord Electronics Ltd. provides the Hugo TT 2 with a comprehensive three-year warranty* which covers defects in materials and workmanship through fair wear and tear. The warranty will be void if any other PSU other than that supplied is used.

*The warranty is transferable with proof of purchase, however is not available on ex-demonstration products.



Please use the form below to record the details of your purchase in the event that these are required at a later date, we further advise that all purchases are registered with Chord Electronics at: chordelectronics.co.uk/register-product/



RETAILER:	
PURCHASE PRICE:	
UNIT COLOUR:	
DATE OF PURCHASE:	
TRANSACTION ID:	

Making a claim & warranty exclusions

2.2

In the unlikely event of a claim, you must provide Chord Electronics with the details of the claim, including your original proof of purchase and serial number in order to validate the nature of the repair.

Upon receipt, Chord Electronics will make an assessment within 30 days and provide a reasonable solution.

All warranty repairs must be carried out by Chord Electronics or an approved service centre to guarantee the quality and safety of the repair.

WARRANTY EXCLUSIONS: The warranty does not cover connected equipment, personal injury or development natural patina of the metalwork and will be null and void if the following is applied: wilful neglect; modification or tampering of the product; improper use of the product; acts of God; damage caused by a connected device; mechanical shock; fire or application of excessive heat or repair/modification by a non-authorized third-party vendor.

**Getting to know
Hugo TT 2**

3.0

- 3.1 Getting to know Hugo TT 2 & drivers
- 3.2 The front panel
- 3.3 The top panel
- 3.4 The rear panel
- 3.5 The remote control

3.0

Getting to know Hugo TT 2

Getting to know Hugo TT 2 & drivers

3.1

The Hugo TT 2 is an extraordinarily powerful leading-edge DAC/preamplifier/headphone amplifier featuring multi-award-winning FPGA technology plus supercapacitor energy storage.

With the Hugo TT 2 the possibilities are endless.

To get the very most out of the device for many years ahead, we recommend familiarising yourself with this user manual.



DRIVERS: The Hugo TT 2 is driverless with Mac OS X and Linux operating systems and only requires drivers for Windows.

These can be found on the product page at:
chordelectronics.co.uk



The front panel

3.2

Whilst an IR remote control is supplied, the front panel of the Hugo TT 2 is the main user interface and can entirely control all user-configurable options, inputs and volume.

There are an additional three headphone outputs which require no additional amplification for headphones up to and exceeding 800Ω.



The top panel

3.3

In addition to the front panel features, the top panel of the device gives visual feedback for the sample rate of the incoming audio file being played using a polychromatic scale illuminated via the looking glass.

The acrylic portion of the top-panel is not only an attractive detail, but houses the aerial for high-resolution Bluetooth playback.



The rear panel

3.4

The rear panel offers a comprehensive connectivity suite, featuring both standard connections and those which are used with other Chord Electronics' devices.

When installing any cable, you must make sure that they securely click into place, especially optical.

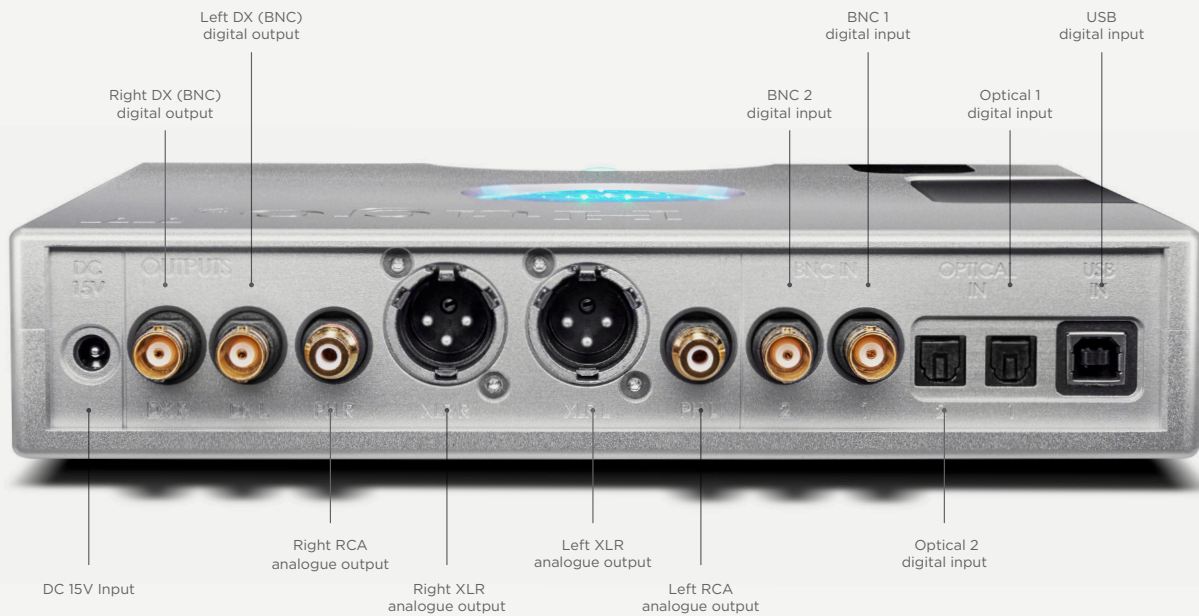

WARNING: Do not use any other power supply other than that supplied. Doing so will invalidate your warranty.

The remote control

3.5

For convenience, a branded infra-red remote control is included with the device.

The remote will operate up to a distance of 10 metres with clear line-of-sight to the infra-red receiver within Hugo TT 2, which is located below the looking glass.

For best operation, do not operate the Hugo TT 2 within a cabinet or place other materials/ devices on top of the device.

Selecting optical input via remote: A single press of the OPT button will select the previously selected optical input. A longer press of 3-seconds will switch to the next optical input.

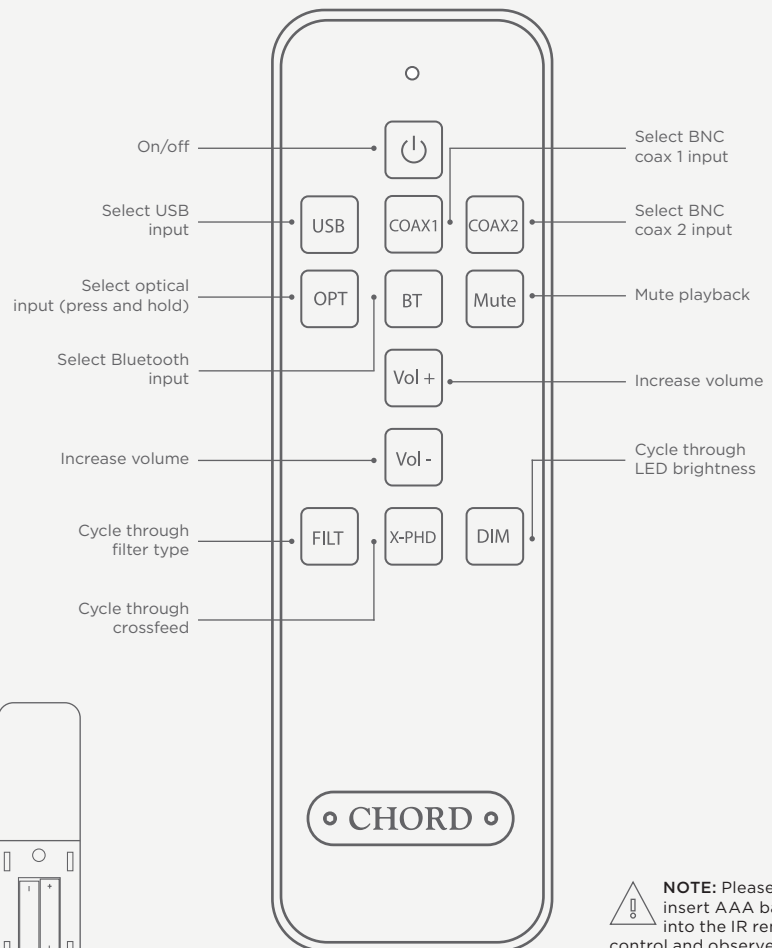

NOTE: Please only insert AAA batteries into the IR remote control and observe the correct orientation as indicated within the remote control. Failure to do so could result in non-operation or battery leakage.

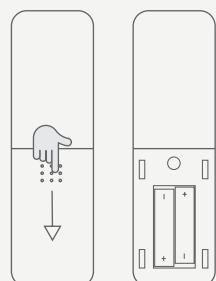

**Setting up
Hugo TT 2**

4.0

4.1 Placement

**4.2 Connecting Hugo TT 2 to equipment
& Hugo TT 2 power-on sequence**

4.0 *Setting up
Hugo TT 2*

Placement

4.1

Whilst the Hugo TT 2 will operate normally within a stack of other Chord Electronics' Table Top (TT) components, it is recommended that the device is allowed to 'breathe'.

Allocating 10cm of space around it to convection-cool during operation is advised.



As the infra-red remote control requires a direct line of sight to the viewing portal, avoid placing objects on top of the Hugo TT 2 or placing it within enclosures.



Connecting an input to Hugo M Scaler & input selection 4.2

When connecting the Hugo TT 2 to equipment within the signal path, ensure all devices are switched off.

It is recommended that once all equipment is properly connected, that the volume setting is operated to its lowest setting.

Then slowly begin raising to a comfortable listening level. Always observe partnering manufacturers' guidelines.



POWER ON SEQUENCE:

When switching on Hugo TT 2, it will initially charge the super-caps, with the display showing CHG.

Then it will enter the initialisation phase, displaying all the settings, and configuring the analogue outputs.

Music playback is not available during initialisation.

During the initialisation phase, the Hugo TT 2's sample rate indicator will cycle through a series of colours.



During this period, do not initiate music playback.

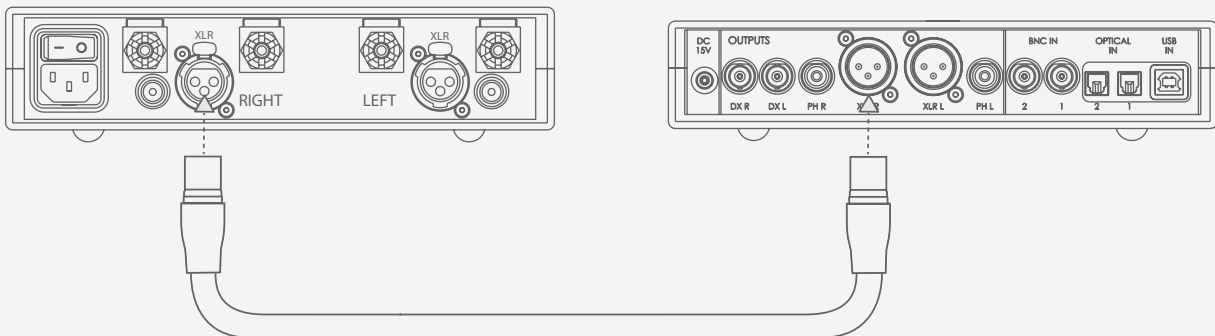
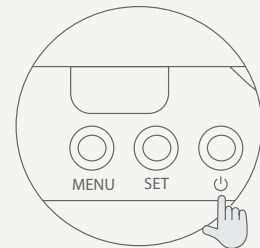

How to navigate the menus

5.0

5.1 The screen & navigating the menu

5.2 The volume ball & its colours and the Sample rate indicator

5.0

How to navigate the menus

The screen & navigating the menu

5.1



THE SCREEN:

For optimal audio performance, the screen of Hugo TT 2 is designed to time out 10-seconds after a period of inactivity. It will be reactivated after a button is pressed on the remote control, or after a menu button is pressed.

The sample rate will continue to illuminate, along with the volume ball unless amplification mode has been activated.

THE MENU: To advance your way through the menu of Hugo TT 2 you may press the 'MENU' button until your chosen setting is displayed. To cycle through the available settings please press the 'SET' button.

Once the 'SET' button is pressed, you do not have to press any other button, the mode will be activated.

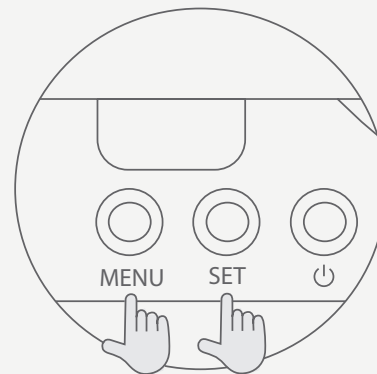
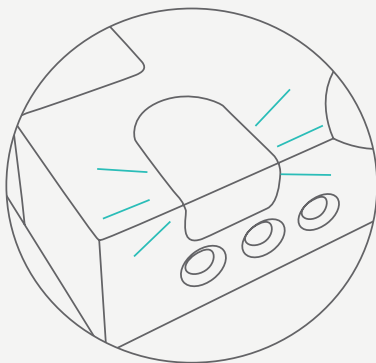

The Volume ball & its colours and the Sample rate indicator

5.2

VOLUME: The volume ball on the front of the unit is responsible for attenuating the signal and providing visual feedback of the range that it is configured to. Hugo TT 2 will remember your previously used volume settings if the unit is switched off.

To reduce the level lightly press and roll the ball to the left, and to raise the level lightly press and roll the ball to the right.

Whilst changing the volume the exact level will be displayed on the screen, and the colour of the ball will change through a polychromatic scale as pictured below.

SAMPLE RATE INDICATOR: During playback, the sample rate will be indicated temporarily on the screen and within the viewing glass which can be found on the top of Hugo TT 2.

Hugo TT 2 is capable of playing files up to 768kHz 32-bit and DSD 512. This is indicated by the following colours:

 **NOT SEEING A CHANGE IN COLOUR FOR SAMPLE RATE?**

If you are unable to see the associated change during playback, this is due to your music playback application, or audio sample rate settings, or not sending the appropriate sample rate through to Hugo TT 2.

Please consult your music playback application user manual for more information.



 **NOTE:** Whilst in DAC mode the volume ball will not illuminate. This is due to the fact that the output is at a fixed level.

Sample frequencies in kHz



Gain range and input

6.0

6.1 Gain range

6.2 Input

6.0

Gain range and input

Gain range

6.1

Hugo TT 2 has a variety of settings to suit various equipment and environments. Please take a moment to familiarise yourself with their meanings and how they may impact your experience.

Before connecting Hugo TT 2 to any equipment it is highly recommended that you manually configure the device to operate in low gain range. The gain ranges are represented as LO G (low gain) or HI G (high gain). Low gain is -9dB lower, or times 0.35, giving a maximum possible OP voltage of 3.3 V RMS.

Gain range is only available when Amplification, or Headphone mode is selected, as when DAC mode is enabled the option will send a fixed 2.5 V RMS output and not offer any user selectable range.

When changing from GAIN mode the outputs are muted for 16 seconds as the analogue is re-initialised. The display will show the mode set during this period. When the volume is displayed, then H (high gain) L (low gain) is shown on the display together with the volume setting in dB.



Warning: Hugo TT 2 is capable of delivering huge amounts of output power whilst in this mode never dramatically increase volume. Doing so could be a risk to your equipment and your hearing!

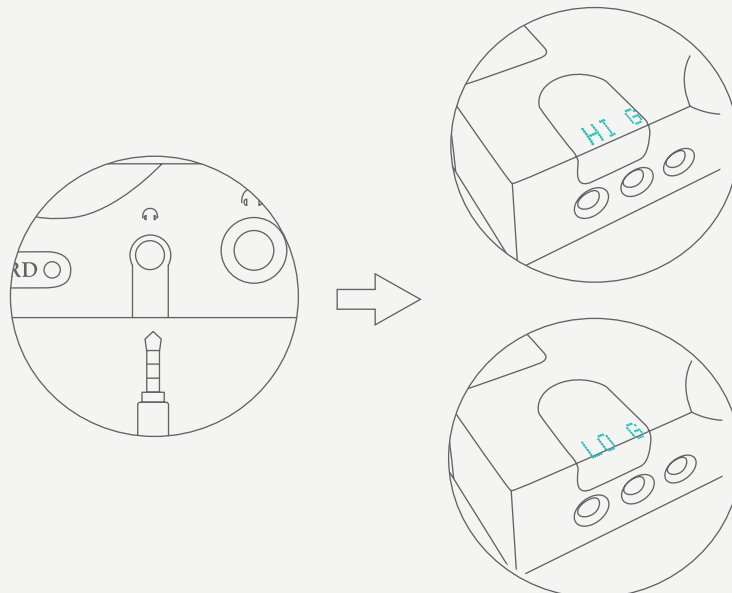

Inputs, sample rates & DSD labeling

6.2

Hugo TT 2 has a total of 6x digital inputs, 1x digital outputs and 5x analogue outputs (not independently controlled).

You can use the menu to navigate through these inputs, but please use the table below to familiarise yourself with the available sample rates:

Where DSD is played back, Hugo TT 2 will display the following:

DSD 1 = DSD 64

DSD 2 = DSD 128

DSD 4 = DSD 256

DSD 8 = DSD 512

USB*	44.1kHz to 768kHz 16bit to 32bit - DSD 64 to DSD 256 (DoP interface), 16bit to 32bit - DSD 64 to DSD 512 (native USB interface)
BNC 1	44.1kHz to 384kHz 16bit to 24bit
BNC 2	44.1kHz to 384kHz 16bit to 24bit
Optical 1	44.1kHz to 192kHz 16bit to 24bit
Optical 2	44.1kHz to 192kHz 24bit
Bluetooth	APT-X
Dual BNC**	Special operation - DBNC: 88.2kHz to 768kHz 24bit

*USB is natively compatible with all Mac OS X and Linux machines without the use of drivers. Windows machines may require a driver, available on the Chord Electronics website.

**Dual BNC is reserved for special operation with Chord Electronics partnering products. Dual BNC does not appear within the menu by default, it will only appear when successfully connected to a partnering product.

Playback modes

7.0

- 7.1 Playback modes
- 7.2 Headphone mode
- 7.3 Amplification mode
- 7.4 DAC mode

7.0 *Playback modes*

Playback modes

7.1

Hugo TT 2 has three user-selectable modes tailored to the intended operation for the device: Headphone mode, Amplification mode and DAC mode.

When headphones are connected to Hugo TT 2, for protection, the device will enter Headphone Mode where only the headphone outputs are enabled. It will not be possible to manually deselect this; only removing the headphones will disengage this mode.

When headphones are disconnected, it is possible to navigate between Amplification Mode or DAC Mode by pressing the 'MENU' button found on the front panel of the device until either 'AMP' or 'DAC' is displayed. Pressing 'SET' will cycle between and engage each mode.



Headphone mode

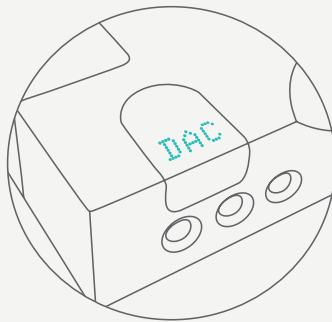

DAC mode



Amplification mode



WARNING: For the protection of your hearing and equipment, please do not navigate between the AMP and DAC without disconnecting Hugo TT 2 from any other device or a source of music.

Headphone mode

7.2

When the Hugo TT 2 detects that headphones have been inserted into one of the three front-panel connectors, the device will enter Headphone Mode, which is for headphone listening only.

When this mode is entered, the Hugo TT 2 will remember the last-used settings (including volume) and will effortlessly drive any impedance headphones including but not limited to 16Ω to 800Ω s, without the need for an external headphone amplifier.

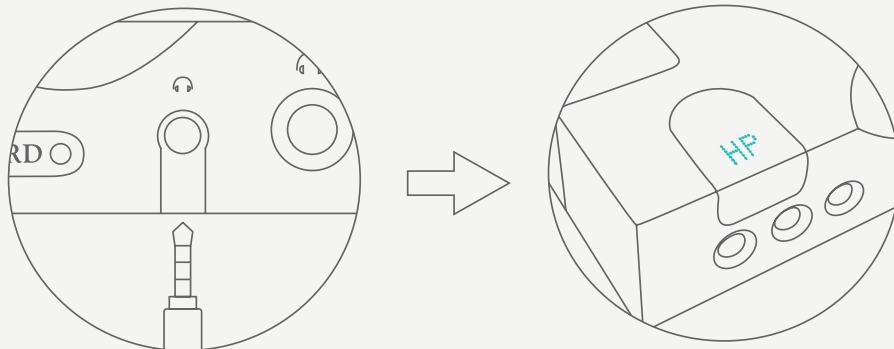

 **WARNING** For your protection, when headphones are connected to the Hugo TT 2, you will be unable to manually exit Headphone mode until they are disconnected.

Amplification mode

7.3

Providing headphones are not connected to the Hugo TT 2, Amplification Mode can be manually engaged.

Amplification Mode deploys the Hugo TT 2's digital preamplifier capabilities enabling the volume to be attenuated to prevent clipping or to feed directly into a powered amplifier or speaker.

When in Amplification Mode, it is possible to drive efficient bookshelf or horn speakers (with suitable cabling), directly from Hugo TT 2's outputs.

Please note that once the Hugo TT 2 enters Amplification Mode, 8W on RCA and 20W on XLR, the rated spec is 7W/8 RCA and 18/8 (XLR balanced).

This enormous power reserve is available thanks to a very high power discrete output stage and super-caps to supply huge dynamic currents.

In most circumstances, where a simple attenuation of the 3V line-level signal is required to match a preamplifier, or power amplifier, you must operate the Hugo TT 2 in Low Gain mode and significantly reduce the volume before raising to a comfortable listening level.

 **WARNING:** For the protection of your hearing and equipment, please do not navigate between the AMP and DAC without disconnecting Hugo TT 2 from any other device or a source of music.

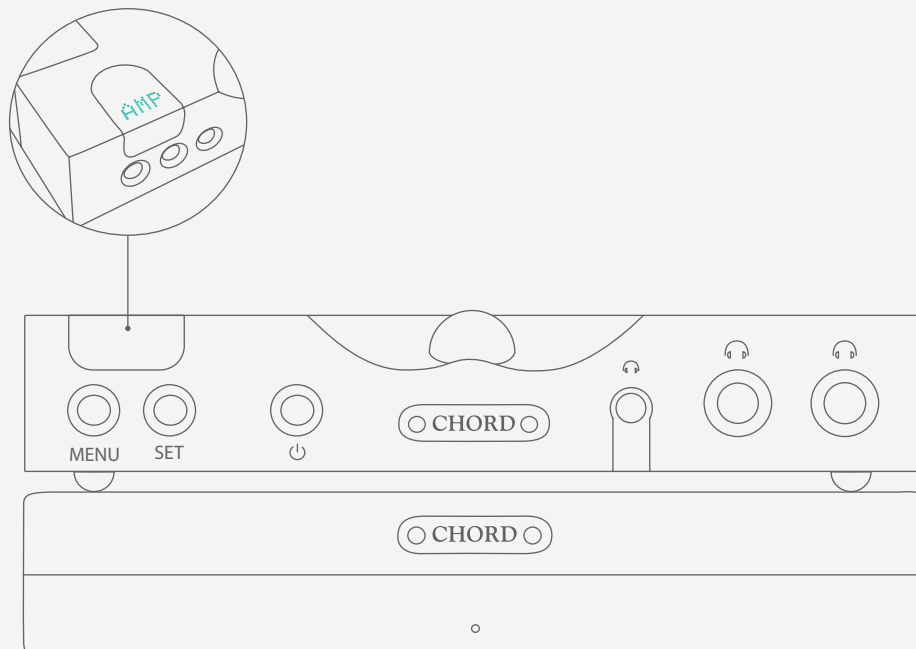

DAC mode

7.4

With headphones disconnected, DAC Mode is selectable. DAC Mode can be employed when used within a conventional audio system, where an external amplifier is present. When this mode is selected, a 2.5V RMS line-level signal will be present on all outputs.

As the output level is fixed within DAC Mode, the Volume ball (and remote control volume) will no longer respond and will no longer illuminate.

Before connecting the Hugo TT 2 to other components, for example a preamplifier or amplifier, please consult the respective user manuals, as they may require a signal less than 2.5V RMS to provide optimum performance. If you require a line-level signal, less than 2.5V, please use Amplification Mode in low gain mode and attenuate the signal as appropriate.

When changing from DAC/AMP mode the outputs are muted for 16 seconds as the analogue is re-initialised. The display will show the mode set during this period.

NOTE: As the output level is fixed on this mode, the volume ball will become unresponsive and will no longer illuminate.

WARNING: Never connect any device incapable of attenuating a line level signal to Hugo TT 2 in DAC Mode. Doing so could result in permanent damage to any connected equipment, along with your hearing.

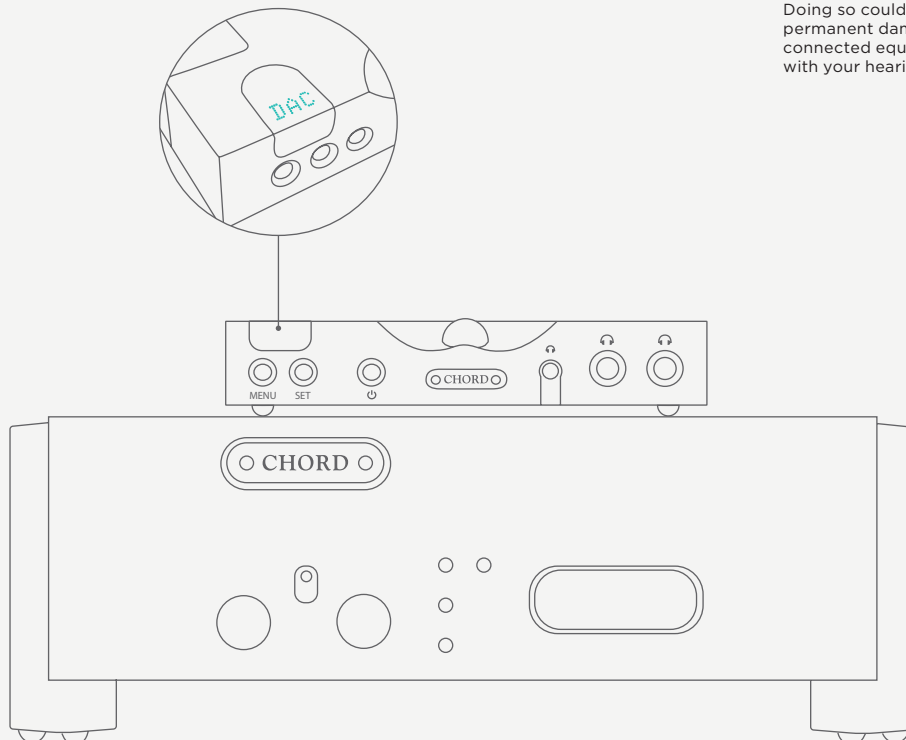

Special features

8.0

- 8.1 Crossfeed (XFD) & Filters (FIL)
- 8.2 Display dimming, settings memory, supercapacitors & galvanic isolation
- 8.3 Display messages

8.0

Special features

Crossfeed (XFD) and Filters (FIL)

8.1

CROSSFEED: Crossfeed is a form of digital processing that blends the left and right channels of a stereo recording to achieve a speaker-like presentation during headphone-listening. It is also a separately configured option when not in Headphone Mode.

The Hugo TT 2 has four available modes of Crossfeed, shown as XFD

on the display:

XFD0: No crossfeed.

XFD1: Minimal crossfeed.

XFD2: Moderate crossfeed.

XFD3: Broad crossfeed.

FILTER: The Hugo TT 2 has the ability to alter the way in which it processes and filters the incoming audio data, which, in turn, has a multi-faceted effect on the presentation of audio. These modes can be especially useful with DSD recordings.

FIL1 - Incisive neutral: the default filtering characteristic; the absolute reference.

FIL2 - Incisive neutral with HF roll-off: contains the same fundamental filtering characteristics of FIL1, however, the HF filter is intended to remove the HF noise from HD (88.2 to 768 kHz) recordings.

FIL3 - Warm: a secondary filtering characteristic for the Hugo TT 2 with a subtle warming tonality.

FIL4 - Warm with HF roll-off: contains the same fundamental filtering characteristics of FIL3, however, the HF filter is intended to remove the HF noise from HD (88.2 to 768 kHz) recordings.

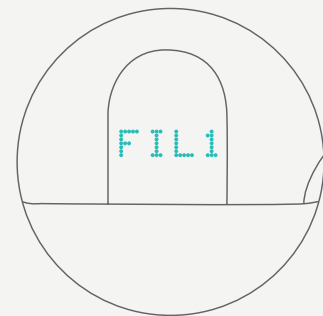

Display dimming, settings memory, supercapacitors & galvanic isolation

8.2

DISPLAY DIMMING: For darker environments, bright LEDs may present a challenge, therefore, Hugo TT 2 offers two brightness settings that can be toggled between within the settings menu;

Full - DIM1: Absolute brightness, designed for well-lit rooms.

Low - DIM2: Low brightness, perfect for dimly lit environments.

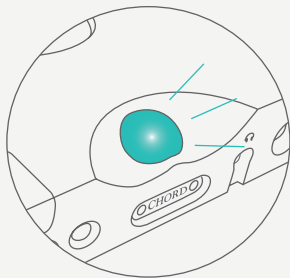

Absolute brightness

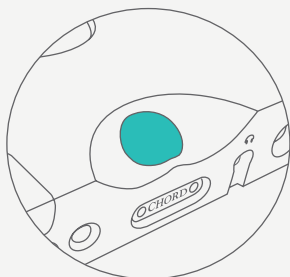

Low brightness



SETTINGS MEMORY: The Hugo TT 2 remembers previous settings, including volume and filters, even when powered down (or with the power supply removed). You do not have to perform any special actions.



SUPERCAPACITOR ENERGY STORAGE: The Hugo TT 2 uses a bank of six supercapacitors within the power supply unit. The supercapacitors are capable of delivering huge linear dynamic currents with a peak output of 5A and 9.3V RMS, more than enough to drive even the most difficult headphone loads or efficient compact loudspeakers given suitable cabling.

Therefore, please respect the output power of Hugo TT 2 and, once all equipment is correctly connected, gently increase the volume until sufficient. Never overload a device with power.



GALVANIC ISOLATION: Galvanic isolation involves isolating the power rails of the data USB input, allowing for greater sonic performance. The Hugo TT 2 features a Class 2 Type-B USB input with this protection. No special attention or cables are required to allow it to however, the USB +5V VBUS must be connected and powered, as the USB decoder device is powered from this line.

Display messages

8.3

During use of Hugo TT 2 you may encounter a number of on-screen display messages. Please use the graph to discover their meanings.

P LO	Power input has too low voltage
P HI	Power input has too high voltage
OT L	Over temperature left - check cabling for short circuits
OT R	Over temperature right - check cabling for short circuits
OT F	The FPGA has exceeded maximum temperature - please improve ventilation
DC L	DC has been detected on digital input, left. If present with no digital source a fault has been found.
DC R	DC has been detected on digital input, left. If present with no digital source a fault has been found.
CHG	Hugo TT 2 is charging the super-capacitors
STBY	Hugo TT 2 is entering standby mode
HP	Headphone mode is entered
DAC	DAC mode is entered
DSD1	DSD 64 is playing back
DSD 2	DSD 128 is playing back
DSD 4	DSD 256 is playing back
DSD 8	DSD 512 is playing back



Chord Electronics Ltd.

